



Paulmann

### Safety Instructions

1, 2, 3, 4, 5, 6, 7, 8, 16, 19,  
22, 23, 24, 29, 32, 33, 34



Info

[www.paulmann.com](http://www.paulmann.com)

Paulmann Licht GmbH  
Quezinger Feld 2  
31832 Springe  
Germany

[www.paulmann.com](http://www.paulmann.com)

Art.-Nr.: 969.43  
969.44  
969.45

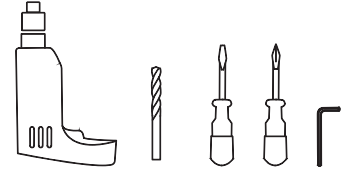
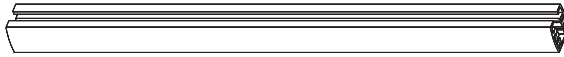

(+MA326) PH 08/19



2x



1x

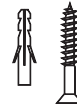

incl.



2x

A

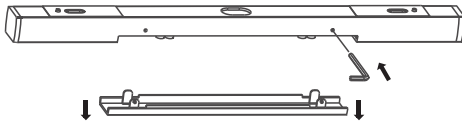

B

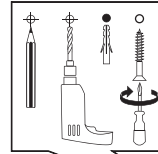

Safety  
Instructions  
Nr. 1-8,19

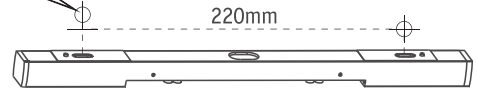

220mm

C1 C2

Cable NYM-J  
3x max. 1,5 mm<sup>2</sup>

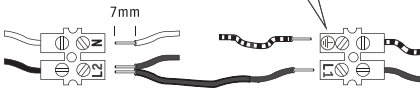

7mm



C1 C2

Cable NYM-J  
5x max. 1,5 mm<sup>2</sup>

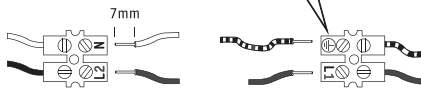

7mm



L2 L1



D

1.

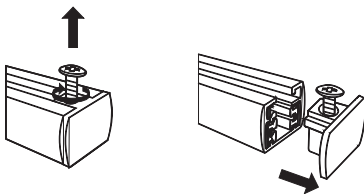

3.

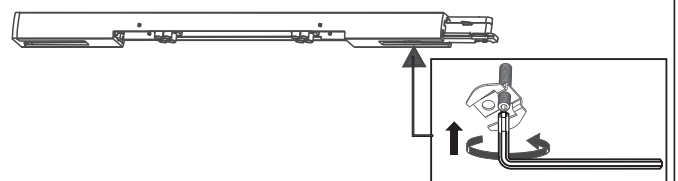

2.



4.

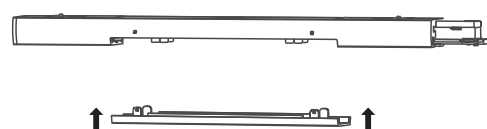

E

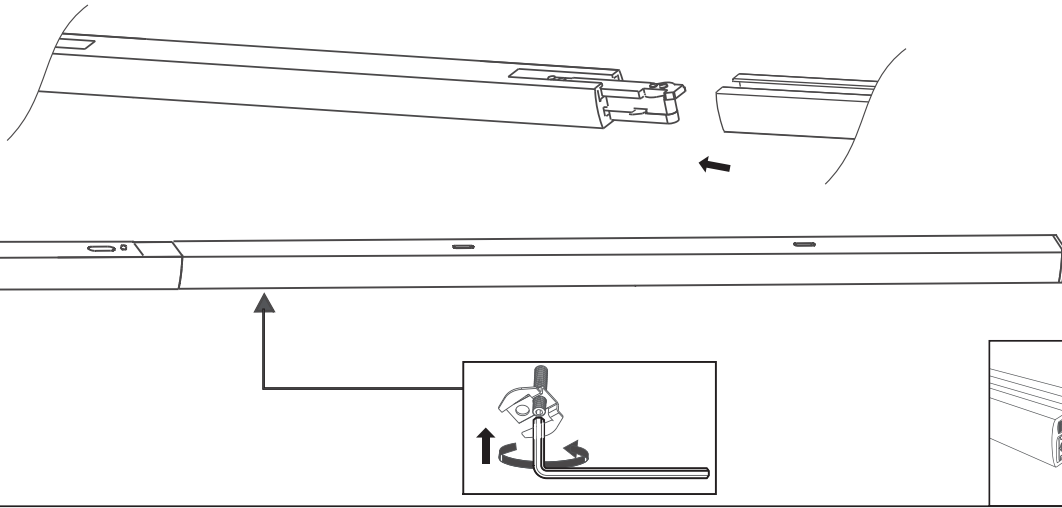

Nr.1-8,19

